

LBC Series

3-phase PSU / Battery Charger

The shelf consists of a ruggedized Battery Charger, PSU with a 3-phase input for 400 / 480 VAC (line to line) and with an output suitable for 110V battery charging.

DC-DC stage to convert the 3-phase input voltage to a bus voltage with battery charging capability. Emphasis is given on high reliability and long life. Two or three parallel independent units inside the shelf with active current sharing are used, which safeguards reliability and partial redundancy of the system.

The PSU includes DSP which enables monitoring of electrical parameters (including input voltage of all 3 phases) and controlling the PSU from system controller. Internal RS485 / CAN bus is used for command, monitoring and diagnostic information that is supplied to the shelf controller and to the external supervising system. External communication is provided by either CAN or Ethernet communication.



Key Features & Benefits

- Shelf with 2-3 power units, 1 control unit and cable harness
- Output power up to 12 kW
- 400 / 480 Vrms 3-phase 50/60 Hz input voltage range (no neutral) with PF > 0.94
- High power density 13 W/in³ per unit
- 92% typical efficiency
- Parallel operation with active current sharing
- Nominal output voltage for 110V battery (adjustable 80 – 137.5 VDC)
- -25 to 55°C of operating ambient temperature without derating
- CAN bus / Ethernet Interface
- Designed to meet Railway standards EN 50155, EN 50121-3-2, EN 45545, NFPA 130

1. MODEL SELECTION

MODEL	POWER	BATTERY VOLTAGE	COMMUNICATION
LBC8000-1110SxxxG*	8000 W	110 V	CAN or Ethernet
LBC12000-1110SxxxG*	12000 W	110 V	CAN or Ethernet

* For details regarding finished good part number, please contact the factory.

2. INPUT SPECIFICATIONS

PARAMETER	DESCRIPTION / CONDITION
Input Voltage	Nominal: 400 - 480 Vrms (line to line without neutral) / 230 – 277 Vrms (line to ground) Permitted variation: 350 – 528 Vrms / 202 – 305 Vrms
Input Frequency	50 – 60 Hz, permitted variation: 47 – 63 Hz
Input Current	≤14 A (LBC8000) / 21 A (LBC12000) at 350 Vrms from each phase Inrush current <190 A (>1 min. cooling period)
Fuse	3 x 20 A, Fast acting, in each power unit (2 or 3 power units inside the shelf)

3. OUTPUT

PARAMETER	DESCRIPTION / CONDITION
Nominal Output Voltage	For 110 V, 100 Ah Battery charging and decoupled consumer output
Output Power Rating	8000 / 12000 W
Output Current	73 / 110 A
Efficiency	Typically 92% at load above 40%
Voltage Setting Accuracy	± 0.5%
Line / Load regulation	±0.5% / ±0.3%
Transient Response	±5% at load variation 10-100% and back; recovery time <4 ms or ±3% at load variation 50-100% and back; recovery time <1.5 ms
Ripple	<1.5% of Vout_nom (BW 20 MHz)

4. PROTECTION SPECIFICATIONS



PARAMETER	DESCRIPTION / CONDITION
Protection	Over temperature protection Input under and over voltage protection Output under and over voltage protection, over current / short circuit protection



5. FUNCTION

PARAMETER	DESCRIPTION / CONDITION	NOTES
Vbat = 30 – 77 V	Battery Low: warning Battery_Low, charging with I _{ch} = nom	Warning by comm. bus (Ethernet or CAN)
Vbat = 77 – 128 V	Battery Normal: charging with I _{ch} = nom	Up to V _{ch} = max @T _{min}
Charging characteristics	V _{ch_max} = f(T): typ. -3 mV / K / cell (curve adjusted exactly according to battery used)	I _{ch_nom} = 16 / 21 A
Failure effect	Charging continues with reduced performance by defective: power modules (redundancy when power reserve), external communication failure, battery temperature sensor failure	When sensor failed, then V _{ch} = min @T _{max}
Battery test	Checked battery connection and battery voltage, repetition on request (typ. once per 12h)	Performed when AC avail.

* V_{ch} - charging voltage, I_{ch} - charging current, I_{con} – consumer current

6. LED SIGNALING (CONTROL UNIT and POWER UNITS)

LED NAME	SYMBOL	COLOR	STATUS	OPERATING CONDITIONS
STATUS		Green	ON Blinking slowly OFF	Charger ready for use Input line ON, Battery not connected Input line not connected
BATTERY CURRENT		Green / Chartreuse / Yellow	ON Blinking slowly OFF	Charging / Current < ±2A / Discharging Over the working range I _{charge} ÷ I _{discharge} Charger Inhibited or Battery not connected
OT / FAIL		Yellow	ON Blinking slowly Blinking fast	Over Temperature or Fail (e.g. Overload) Safe mode (reduced voltage) Inhibit activated

LED NAME	SYMBOL	COLOR	STATUS	OPERATING CONDITIONS
AC-OK		Green	ON Blinking slowly OFF	AC input voltage within operation range Over/under voltage Input line not connected
DC-OK		Green / Chartreuse / Yellow	ON Blinking slowly OFF	Output current 0-33 % / 33-66 % / 66-100 % Over/under voltage Output inhibited
OT / FAIL		Yellow	ON Blinking slowly Blinking fast	Over Temperature conditions inside the unit Fan fail Communication error

7. SAFETY, REGULATORY AND EMI SPECIFICATIONS

PARAMETER	DESCRIPTION / CONDITION	CRITERION
Emissions Requirements	Radiated Emissions (EN50121-3-2) Conducted Emissions (EN50121-3-2)	
Immunity Requirements	Electrostatic Discharge (IEC/EN 61000-4-2)	Level 4: ±6 kV contact ±8 kV air Criterion B
	Radiated Electromagnetic Field (IEC/EN 61000-4-3)	10-20 V/m 10 kHz-6 GHz Criterion A
	Electrical Fast Transient (EFT)/Burst (IEC 61000-4-4)	Level 3: ±2 kV Criterion A
	Surge Immunity (IEC/EN 61000-4-5)	Level 3: ±1 kV DM ±2 kV CM Criterion B
	RF Conducted Immunity (IEC/EN 61000-4-6)	Level 3: 10 V 150kHz-80MHz Criterion A
Useful Life Assessment	>5 years life at ambient temperature of +55°C. Fan – externally accessible for a potential replacement.	
Other standards	Railway applications EN 50155, EN 50121-3-2, EN 45545, NFPA 130	

8. ENVIRONMENTAL SPECIFICATIONS

PARAMETER	DESCRIPTION / CONDITION
Humidity	According IEC 60068-2-78 operating range 10%RH-90%RH
Operating Temperature	Ambient air temperature: -25°C to +55°C
Storage Temperature	-40 to +85°C
Vibration	IEC61373-1999, operating, class B, 5-150 Hz, functional test, long life test
Shock	IEC61373-1999, non operating, class B, single half-sine pulse 30/30/50 m/s ²

9. CONNECTORS

PARAMETER	CONDITIONS / DESCRIPTION	
Input connector X1	4-pin terminal block HDFK 10-HV (Phoenix Contact)	
Output connector X2	3-pin terminal block HDFK 50/Z (Phoenix Contact)	
Signal connector X3	15-pin Combicon MSTBA 2.5 (Phoenix Contact)	
Ethernet comm. Connector X4	4-pin M12 D-Coding Female (S102)	LED left - data activity, LED right - operating
CAN comm. Connector X5	9-pin D-SUB Male (S101)	
CAN comm. Connector X6	9-pin D-SUB Female (S101)	

9.1 INPUT POWER CONNECTOR X1 – PINOUT

SIGNAL NAME	PIN #	TYPE	RECOMMENDED WIRES	ABSOLUTE V MAX ABSOLUTE I MAX
Earth		Earth / Chassis		
AC Line 1	L1	Input Power AC Fused	4 mm ²	500 Vrms (line to line) 16 Arms (per line)
AC Line 2	L2	Input Power AC Fused		
AC Line 3	L3	Input Power AC Fused		

Connector type: 4-pin terminal block HDFK 10-HV/Z (Phoenix Contact)
 Mating part: Wires, min. 4 mm²

9.2 OUTPUT CONNECTOR X2 – PINOUT

SIGNAL NAME	PIN #	TYPE	SIGNAL REFERENCE	NOTE	V MAX I MAX
Consumer +	1	Output Power DC	Common -	16 - 50 mm ²	
BAT +	2	Output Power DC	Common -	16 - 50 mm ²	
Common -	3	Output Power DC		16 - 50 mm ²	

Connector type: 3-pin terminal block HDFK 50/Z (Phoenix Contact)
 Mating part: Wires

9.3 ETHERNET CONNECTOR X4 – PINOUT (S102 Version)

SIGNAL NAME	PIN #	TYPE	SIGNAL REFERENCE	NOTE	V MAX I MAX
TxData+	1	Communication Data		10/100Mbit	
RxData+	2	Communication Data		10/100Mbit	
TxData-	3	Communication Data		10/100Mbit	
RxData-	4	Communication Data		10/100Mbit	

Connector type: 4-pin M12 D-coded female 1534630 (Phoenix Contact)
 Mating part: 4-pin M12 D-coded male 1521258 (Phoenix Contact)

9.4 CAN-BUS CONNECTOR X5, X6 – PINOUT (S101 Version)

SIGNAL NAME	PIN #	TYPE	SIGNAL REFERENCE	NOTE	V MAX I MAX
CAN +	7	Communication Data	CAN-		
CAN -	2	Communication Data	CAN+		
GND	3				

Connector type: X5: 9-pin D-SUB male (Harting) X6: 9-pin D-SUB female (Harting)
 Mating part: 9-pin D-SUB female / male

9.5 SIGNAL CONNECTOR X3 – PINOUT

SIGNAL NAME	PIN #	TYPE	SIGNAL REFERENCE	LOW LEVEL HIGH LEVEL	V MAX I MAX
Vt1	1	Battery Voltage Sense Vt1	Vb2		
Vm1	2	Battery Voltage Sense Vm1	Vb2		
Vb1	3	Battery Voltage Sense Vb1	Vb2		
Vt2	4	Battery Voltage Sense Vt2	Vb2		
Vm2	5	Battery Voltage Sense Vm2	Vb2		
N.C.	6				
TB1H	7	Temperature sensor 1 High	TB1L		
TB1L	8	Temperature sensor 1 Low			
TB2H	9	Temperature sensor 2 High	TB2L		
TB2L	10	Temperature sensor 2 Low			
N.C.	11				
INH	12	Inhibit, pull high to inhibit charger	Vb2	0 – 138 V	
P_LIM	13	Power Limitation, pull high to limit power	Vb2	0 – 138 V	
FA	14	Floating relay contact, normally open, closed when in fault condition			
FB	15				

Connector type: Combicon MSTB2.5/15-GF-1776825 male (Phoenix Contact)
 Mating part: Combicon MSTB2.5/15-STF-1786967 female (Phoenix Contact)

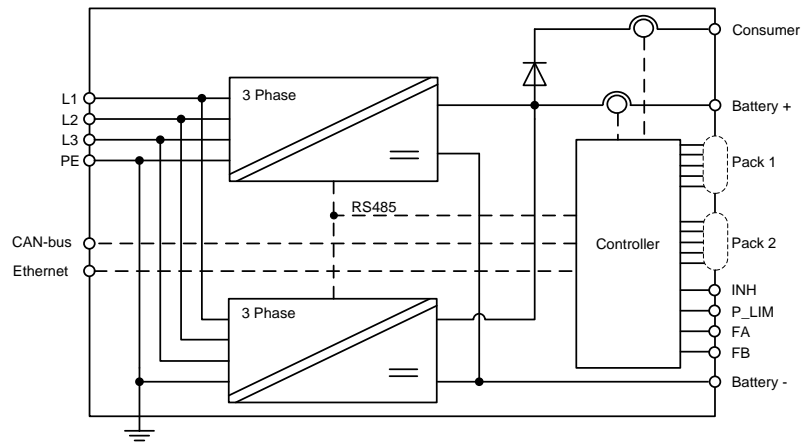

Figure 1. Block Diagram of Battery Charger Rack

10. MECHANICAL SPECIFICATIONS

PARAMETER	CONDITIONS / DESCRIPTION	
Rack Dimensions	347/406 x 600 x 166 mm / 13.7/16 x 23.6 x 6.5 in (W x D x H) (2 - 3 PSU inside the shelf with Control Unit and distribution)	
Weight	23.5 kg (8 kW) / 29.7 kg (12 kW)	
Cooling	Externally accessible serviceable fans placed (maximal power dissipation ~ 900 W)	
Insulation	3.0 kVAC input to output	420 VAC output to chassis
	1.5 kVAC input to chassis	420 VAC comm. signals to chassis
Enclosure	IP20	

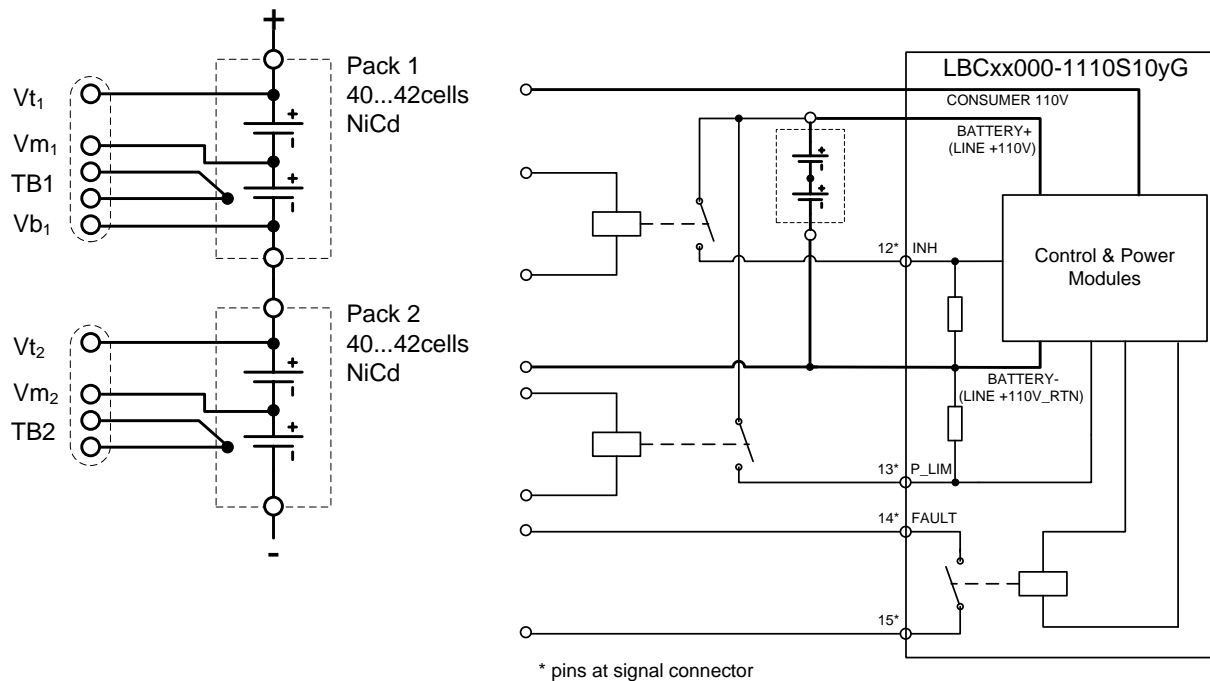

Figure 2. Battery and Static Signals Connector X3 (Temperature Sensor Integrated in Battery Pack)

For more information on these products consult: tech.support@psbel.com

NUCLEAR AND MEDICAL APPLICATIONS - Products are not designed or intended for use as critical components in life support systems, equipment used in hazardous environments, or nuclear control systems.

TECHNICAL REVISIONS - The appearance of products, including safety agency certifications pictured on labels, may change depending on the date manufactured. Specifications are subject to change without notice.