



CHB100W Series Application Note V13 November 2013

ISOLATED DC-DC CONVERTER CHB100W SERIES APPLICATION NOTE



Approved By:

Department	Approved By	Checked By	Written By
Research and Development Department	Enoch	Lisa	Joyce
		Hugo	
Quality Assurance Department	Jack	Benny	



CHB100W Series

Application Note V13 November 2013

Contents

1. Introduction	3
2. DC-DC Converter Features.....	3
3. Electrical Block Diagram	3
4. Technical Specifications.....	4
5. Main Features and Functions.....	8
5.1 <i>Operating Temperature Range</i>	8
5.2 <i>Output Voltage Adjustment</i>	8
5.3 <i>Over Current Protection</i>	8
5.4 <i>Output Over Voltage Protection</i>	8
5.6 <i>Remote On/Off</i>	8
5.7 <i>UVLO (Under Voltage Lock Out)</i>	8
5.8 <i>Over Temperature Protection</i>	8
6. Applications.....	8
6.1 <i>Recommended Layout, PCB Footprint and Soldering Information</i>	8
6.2 <i>Convection Requirements for Cooling</i>	8
6.3 <i>Thermal Considerations</i>	9
6.4 <i>Input Capacitance at the Power Module</i>	9
6.5 <i>Power Derating</i>	10
6.6 <i>Half Brick Heat Sinks</i>	12
6.7 <i>Efficiency VS. Load</i>	13
6.8 <i>Test Set-Up</i>	15
6.9 <i>Output Voltage Adjustment</i>	15
6.10 <i>Output Remote Sensing</i>	16
6.11 <i>Output Ripple and Noise</i>	17
6.12 <i>Output Capacitance</i>	17
7. Safety & EMC.....	18
7.1 <i>Input Fusing and Safety Considerations</i>	18
7.2 <i>EMC Considerations</i>	18
8. Part Number.....	23
9. Mechanical Specifications	23
9.1 <i>Mechanical Outline Diagrams</i>	23



CHB100W Series

Application Note V13 November 2013

1. Introduction

The CHB100W series offers 100 watts of output power with high power density in an industry standard half-brick package. The CHB series has wide (4:1) input voltage ranges of 9-36 and 18-75VDC and provides a precisely regulated output. This series has features such as high efficiency, 1500VDC isolation and a case operating temperature range of -40°C to 100°C . The modules are fully protected against input UVLO (under voltage lock out), output short circuit, output overvoltage and overtemperature conditions. Furthermore, the standard control functions include remote on/off and output voltage trimming. All models are highly suited to telecommunications, distributed power architectures, battery operated equipment, industrial, and mobile equipment applications.

2. DC-DC Converter Features

- 100W Isolated Output
- Efficiency (at full load) up to 88%
- Regulated Output
- Fixed Switching Frequency
- Input Under Voltage Lockout Protection
- Over Current Protection
- Remote On/Off
- Continuous Short Circuit Protection
- Industry Standard Half-Brick Package
- Fully Isolated to 1500VDC
- CE Mark Meets 2004/108/EC
- UL60950-1 Approval (Except 28 Vout)

3. Electrical Block Diagram

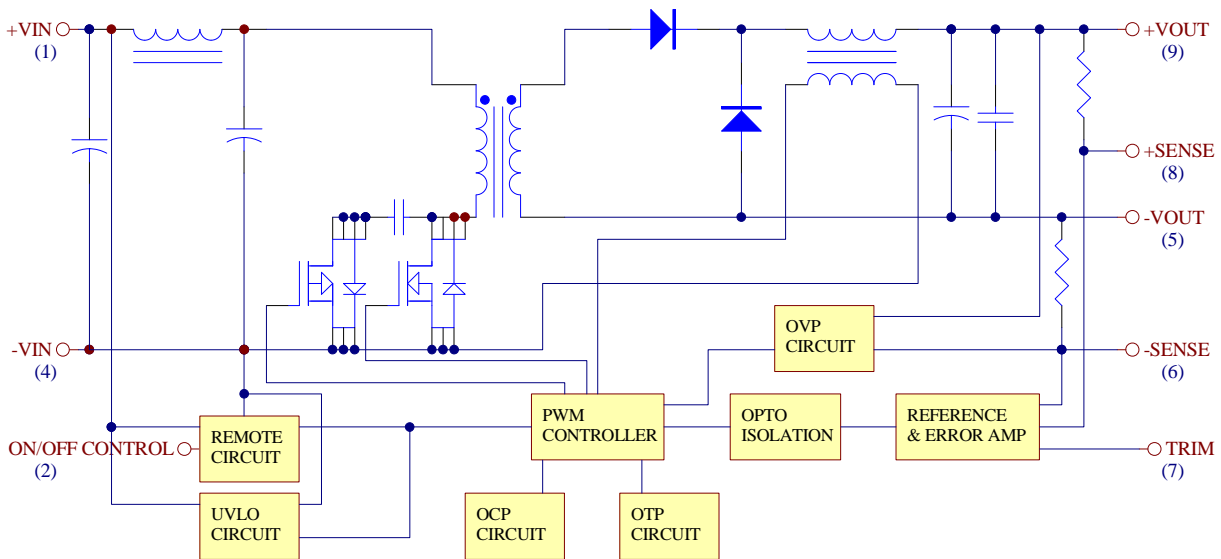

Electrical Block Diagram



CHB100W Series

Application Note V13 November 2013

4. Technical Specifications

(All specifications are typical at nominal input, full load at 25°C unless otherwise noted.)

ABSOLUTE MAXIMUM RATINGS

PARAMETER	NOTES and CONDITIONS	Device	Min.	Typical	Max.	Units
Input Voltage						
Continuous		24SXX	9	24	36	V_{dc}
		48SXX	18	48	75	
Transient	100ms	24SXX			50	V_{dc}
		48SXX			100	
Operating Case Temperature			-40		100	°C
Storage Temperature			-55		105	°C
Isolation Voltage	1 minute; input/output, input/case, output/case		1500			V_{dc}

INPUT CHARACTERISTICS

PARAMETER	NOTES and CONDITIONS	Device	Min.	Typical	Max.	Units
Operating Input Voltage		24SXX	9	24	36	V_{dc}
		48SXX	18	48	75	
Input Undervoltage Lockout						
Turn-On Voltage Threshold		24SXX	8	8.5	8.8	V_{dc}
		48SXX	16.5	17	17.5	
Turn-Off Voltage Threshold		24SXX	7.7	8	8.3	V_{dc}
		48SXX	15.5	16	16.5	
Lockout Hysteresis Voltage		24SXX		0.6		V_{dc}
		48SXX		0.9		
Maximum Input Current	100% Load, $V_{in}=9V$ for 24SXX	24SXX		13.6		A
	100% Load, $V_{in}=18V$ for 48SXX	48SXX		6.8		
No-Load Input Current		24S33		35		mA
		24S05		35		
		24S12		35		
		24S15		35		
		24S24		35		
		24S28		50		
		24S48		35		
		48S33		30		
		48S05		30		
		48S12		30		
		48S15		30		
		48S24		30		
		48S28		50		
48S48		30				
Inrush Current (I^2t)					0.1	A^2s
Input Reflected Ripple Current	P-P thru 12uH inductor, 5Hz to 20MHz			30		mA



CHB100W Series

Application Note V13 November 2013

OUTPUT CHARACTERISTICS

PARAMETER	NOTES and CONDITIONS	Device	Min.	Typical	Max.	Units
Output Voltage Set Point	V_{in} =Nominal V_{in} , $I_o = I_{o_max}$, $T_c=25^\circ\text{C}$	$V_o=3.3\text{V}$	3.2505	3.3	3.3495	V_{dc}
		$V_o=5.0\text{V}$	4.925	5	5.075	
		$V_o=12\text{V}$	11.82	12	12.18	
		$V_o=15\text{V}$	14.775	15	15.225	
		$V_o=24\text{V}$	23.64	24	24.36	
		$V_o=28\text{V}$	27.58	28	28.42	
		$V_o=48\text{V}$	47.28	48	48.72	
Output Voltage Regulation						
Load Regulation	$I_o=I_{o_min}$ to I_{o_max}				± 0.2	%
Line Regulation	V_{in} =low line to high line				± 0.2	%
Temperature Coefficient	$T_c=-40^\circ\text{C}$ to 100°C				± 0.03	%/ $^\circ\text{C}$
Output Voltage Ripple and Noise						
Peak-to-Peak	5Hz to 20MHz bandwidth, Full load, 10uF tantalum and 1.0uF ceramic capacitors (48V: Full load, 1uF ceramic capacitors)	$V_o= 3.3\&5.0\text{V}$			100	mV
		$V_o=12\&15\text{V}$			150	
		$V_o=24\text{V}$			240	
		$V_o=24\text{V}$			280	
		$V_o=28\text{V}$			280	
		$V_o=48\text{V}$			480	
RMS	5Hz to 20MHz bandwidth, Full load, 10uF solid tantalum and 1.0uF ceramic capacitors (48V: Full load, 1uF ceramic capacitors)	$V_o= 3.3\&5.0\text{V}$			40	mV
		$V_o=12\& 5\text{V}$			60	
		$V_o=24\&28\text{V}$			100	
		$V_o=48\text{V}$			200	
Operating Output Current Range		$V_o=3.3 \text{ V}$	0		20	A
		$V_o=5.0 \text{ V}$	0		20	
		$V_o=12 \text{ V}$	0		8.3	
		$V_o=15 \text{ V}$	0		6.7	
		$V_o=24 \text{ V}$	0		4.17	
		$V_o=28 \text{ V}$	0		3.57	
		$V_o=48 \text{ V}$	0		2.08	
Output DC Current Limit Inception	Output Voltage=90% Nominal Output Voltage		110	125	140	%
Maximum Output Capacitance	Full load (resistive)	$V_o=3.3\text{V}$	0		20000	uF
		$V_o=5.0\text{V}$	0		20000	
		$V_o=12\text{V}$	0		8300	
		$V_o=15\text{V}$	0		6700	
		$V_o=24\text{V}$	0		2200	
		$V_o=28\text{V}$	0		2200	
		$V_o=48\text{V}$	47		470	



CHB100W Series

Application Note V13 November 2013

DYNAMIC CHARACTERISTICS

PARAMETER	NOTES and CONDITIONS	Device	Min.	Typical	Max.	Units
Output Voltage Current Transient						
Step Change in Output Current	75% to 100% of I_{o_max}				±5	%
Setting Time (within 1% V_{out} nominal)	$d_i/d_r=0.1A/us$				500	us
Turn-On Delay and Rise Time						
Turn-On Delay Time, From On/Off Control	$V_{on/off}$ to 10% V_{o_set}	All		10		ms
Turn-On Delay Time, From Input	V_{in_min} to 10% V_{o_set}	All		10		ms
Output Voltage Rise Time	10% V_{o_set} to 90% V_{o_set}	All		10		ms

EFFICIENCY

PARAMETER	NOTES and CONDITIONS	Device	Min.	Typical	Max.	Units
100% Load		24S3V3		81.5		%
		24S05		83.5		
		24S12		85		
		24S15		86.5		
		24S24		86		
		24S28		86		
		24S48		82.5		
		48S33		80.5		
		48S05		86		
		48S12		86.5		
		48S15		87.5		
		48S24		88		
		48S28		86		
		48S48		84.5		

ISOLATION CHARACTERISTICS

PARAMETER	NOTES and CONDITIONS	Device	Min.	Typical	Max.	Units
Isolation Voltage	1 minute; input/output, input/case, output/case				1500	V_{dc}
Isolation Resistance			10			$M\Omega$
Isolation Capacitance				1000		pF

FEATURE CHARACTERISTICS

PARAMETER	NOTES and CONDITIONS	Device	Min.	Typical	Max.	Units
Switching Frequency				250		KHz
ON/OFF Control, Positive Remote On/Off logic						
Logic Low (Module Off)	$V_{on/off}$ at $I_{on/off}=1.0mA$				1.8	V
Logic High (Module On)	$V_{on/off}$ at $I_{on/off}=0.0uA$		3.5 or Open Circuit		75	V



CHB100W Series

Application Note V13 November 2013

ON/OFF Control, Negative Remote On/Off logic						
Logic High (Module Off)	$V_{on/off}$ at $I_{on/off}=0.0uA$		3.5 or Open Circuit		75	V
Logic Low (Module On)	$V_{on/off}$ at $I_{on/off}=1.0mA$				1.8	V
ON/OFF Current (for both remote on/off logic)	$I_{on/off}$ at $V_{on/off}=0.0V$			0.3	1	mA
Leakage Current (for both remote on/off logic)	Logic High, $V_{on/off}=15V$				30	uA
Off Converter Input Current	Shutdown input idle current			4	10	mA
Output Voltage Trim Range	$P_{out}=\text{max rated power}$		-10		+10	%
Output Over Voltage Protection			115	125	140	%
Over-Temperature Shutdown				105		°C

GENERAL SPECIFICATIONS

PARAMETER	NOTES and CONDITIONS	Device	Min.	Typical	Max.	Units
MTBF	$I_o=100\%$ of I_{o_max} ; $T_a=25^\circ C$ per MIL-HDBK-217F			700		K hours
Weight				95		grams



CHB100W Series

Application Note V13 November 2013

5. Main Features and Functions

5.1 Operating Temperature Range

The CHB100W series converters can be operated within a wide case temperature range of -40°C to 100°C. Consideration must be given to the derating curves when ascertaining maximum power that can be drawn from the converter. The maximum power drawn from open half brick models is influenced by usual factors, such as:

- Input voltage range
- Output load current
- Forced air or natural convection

5.2 Output Voltage Adjustment

Section 6.8 describes in detail how to trim the output voltage with respect to its set point. The output voltage on all models is adjustable within the range of +10% to -10%.

5.3 Over Current Protection

All models have internal over current and continuous short circuit protection. The unit operates normally once the fault condition is removed. At the point of current limit inception, the converter will go into hiccup mode protection.

5.4 Output Over Voltage Protection

The output over voltage protection consists of circuitry that internally limits the output voltage. If more accurate output over voltage protection is required then an external circuit can be used via the remote on/off pin.

5.6 Remote On/Off

The CHB100W series allows the user to switch the module on and off electronically with the remote on/off feature. All models are available in “positive logic” and “negative logic” (optional) versions. The converter turns on if the remote On/Off pin is high (>3.5Vdc or open circuit). Setting the pin low (<1.8Vdc) will turn the converter off. The signal level of the remote on/off input is defined with respect to ground. If not using the remote on/off pin, leave the pin open (converter will be on). Models with part number suffix “N” are the “negative logic” remote On/Off version. The unit turns off if the remote On/Off pin is high (>3.5Vdc or open circuit). The converter turns on if the On/Off pin input is low (<1.8Vdc). Note that the converter is off by default.

5.7 UVLO (Under Voltage Lock Out)

Input under voltage lockout is standard on the CHB100W unit. The unit will shut down when the input voltage drops below a threshold, and the unit will operate when the input voltage goes above the upper threshold.

5.8 Over Temperature Protection

These modules have an over temperature protection circuit to safeguard against thermal damage.

Shutdown occurs with the maximum case reference temperature is exceeded. The module will restart when the case temperature falls below over temperature shutdown threshold.

6. Applications

6.1 Recommended Layout, PCB Footprint and Soldering Information

The system designer or end user must ensure that metal and other components in the vicinity of the converter meet the spacing requirements for which the system is approved. Low resistance and inductance PCB layout traces are the norm and should be used where possible. Due consideration must also be given to proper low impedance tracks between power module, input and output grounds. The recommended soldering profile and PCB layout are shown below.

Lead Free Wave Soldering Profile

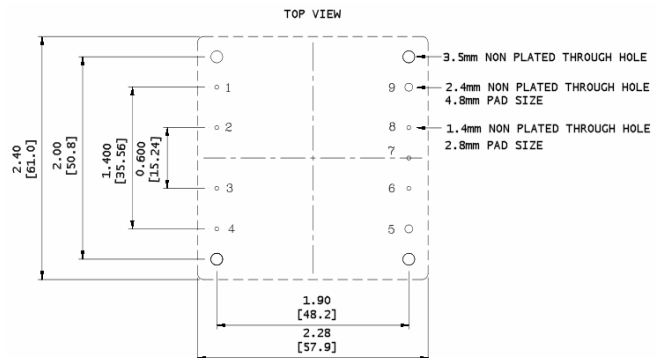
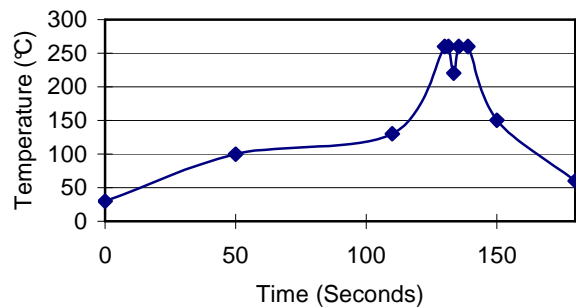

6.2 Convection Requirements for Cooling

To predict the approximate cooling needed for the half brick module, refer to the power derating curves in section 6.4. These derating curves are approximations of the ambient temperatures and airflows required to keep the power module temperature below its maximum rating. Once the module is assembled in the actual system, the module’s temperature should be monitored to ensure it does not exceed 100°C as measured at the center of the top of the case (thus verifying proper cooling).



CHB100W Series

Application Note V13 November 2013

6.3 Thermal Considerations

The power module operates in a variety of thermal environments; however, sufficient cooling should be provided to help ensure reliable operation of the unit. Heat is removed by conduction, convection, and radiation to the surrounding environment. The test data is presented in section 6.4. The power output of the module should not be allowed to exceed rated power ($V_{o_set} \times I_{o_max}$).

6.4 Input Capacitance at the Power Module

The converters must be connected to low AC source impedance. To avoid problems with loop stability source inductance should be low. Also, the input capacitors (C_{in}) should be placed close to the converter input pins to decouple distribution inductance. However, the external input capacitors are chosen for suitable ripple handling capability. Low ESR capacitors are good choice. Circuit as shown as below represents typical measurement methods for reflected ripple current. C_1 and L_1 simulate a typical DC source impedance. The input reflected-ripple current is measured by current probe to oscilloscope with a simulated source Inductance (L_1).

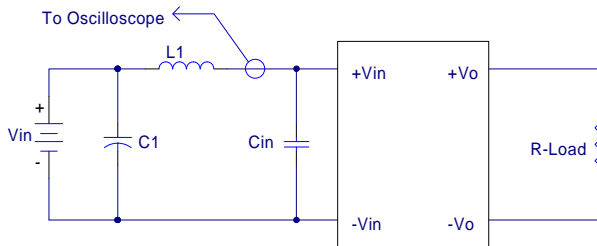

L1: 12uH
C1: 220uF ESR<0.1ohm @100KHz
Cin: 33uF ESR<0.7ohm @100KHz
Input Reflected-Ripple Test Setup



CHB100W Series

Application Note V13 November 2013

6.5 Power Derating

The operating case temperature range of CHB100W series is -40°C to +100°C. When operating the CHB100W series, proper derating or cooling is needed. The maximum case temperature under any operating condition should not exceed 100°C.

The following curve is the de-rating curve of CHB100W series without heat sink.

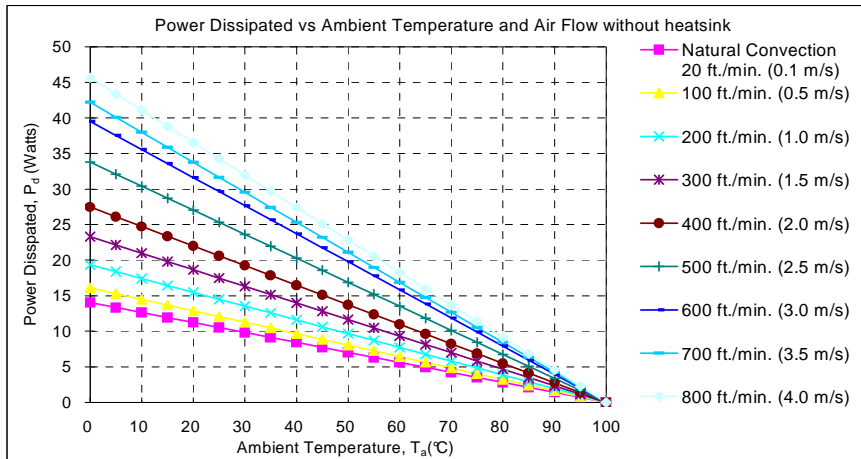

AIR FLOW RATE	TYPICAL R _{ca}
Natural convection	7.12°C/W
20ft./min. (0.1m/s)	6.21°C/W
100 ft./min. (0.5m/s)	5.17°C/W
200 ft./min. (1.0m/s)	4.29°C/W
300 ft./min. (1.5m/s)	3.64°C/W
400 ft./min. (2.0m/s)	2.96°C/W
500 ft./min. (2.5m/s)	2.53°C/W
600 ft./min. (3.0m/s)	2.37°C/W
700 ft./min. (3.5m/s)	2.19°C/W
800 ft./min. (4.0m/s)	

Example:

What is the minimum airflow necessary for a CHB100W-48S12 operating at nominal line voltage, an output current of 8.3A, and a maximum ambient temperature of 40°C?

Solution:

Given:

$$V_{in}=48V_{dc}, V_o=12V_{dc}, I_o=8.3A$$

Determine Power dissipation (P_d):

$$P_d = P_i - P_o = P_o(1-\eta)/\eta$$

$$P_d = 12V \times 8.3A \times (1-0.865)/0.865 = 15.54Watts$$

Determine airflow:

$$\text{Given: } P_d = 15.54W \text{ and } T_a = 40^\circ C$$

Check Power Derating curve:

$$\text{Minimum airflow} = 400 \text{ ft./min.}$$

Verify:

Maximum temperature rise is

$$\Delta T = P_d \times R_{ca} = 15.54W \times 3.64 = 56.6^\circ C.$$

Maximum case temperature is

$$T_c = T_a + \Delta T = 96.6^\circ C < 100^\circ C.$$

Where:

The R_{ca} is thermal resistance from case to ambient environment.

T_a is ambient temperature and T_c is case temperature.



CHB100W Series

Application Note V13 November 2013

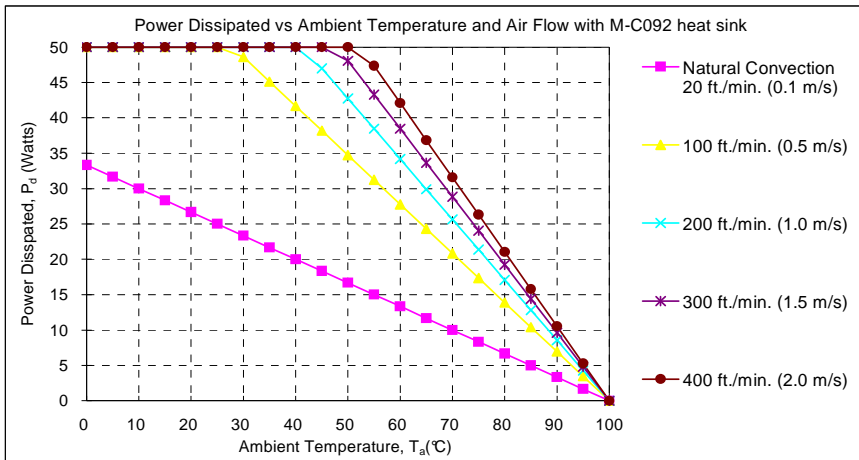

AIR FLOW RATE	TYPICAL R _{ca}
Natural convection 20ft./min. (0.1m/s)	3.00°C/W
100 ft./min. (0.5m/s)	1.44°C/W
200 ft./min. (1.0m/s)	1.17°C/W
300 ft./min. (1.5m/s)	1.04°C/W
400 ft./min. (2.0m/s)	0.95°C/W

Example (with heat sink M-C092):

What is the minimum airflow necessary for a CHB100W-48S05 operating at nominal line voltage, an output current of 20A, and a maximum ambient temperature of 40°C .

Solution:

Given:

$$V_{in}=48V_{dc}, V_o=5V_{dc}, I_o=20A$$

Determine Power dissipation (P_d):

$$P_d=P_i-P_o=P_o(1-\eta)/\eta$$

$$P_d=5.0 \times 20 \times (1-0.86)/0.86=16.28 \text{ Watts}$$

Determine airflow:

Given: Pd=16.28W and Ta=40°C

Check above Power derating curve:

P_d<20W, Natural Convection

Verify:

Maximum temperature rise is

$$\Delta T = P_d \times R_{ca} = 16.28 \times 3 = 48.84^\circ\text{C}$$

Maximum case temperature is

$$T_c = T_a + \Delta T = 88.84^\circ\text{C} < 100^\circ\text{C}$$

Where:

The R_{ca} is thermal resistance from case to ambient environment.

T_a is ambient temperature and T_c is case temperature.



CHB100W Series

Application Note V13 November 2013

6.6 Half Brick Heat Sinks:

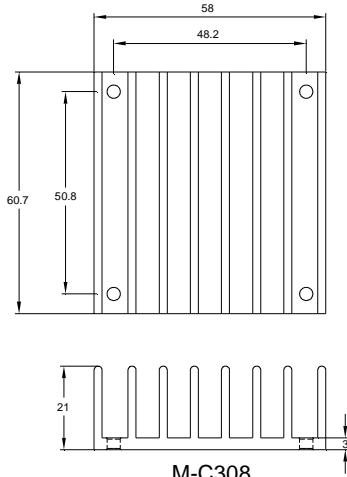

M-C308 (G6620400201)
Longitudinal Heat Sink

Rca:
 3.90°C/W (typ.), natural convection
 1.74°C/W (typ.), at 100LFM
 1.33°C/W (typ.), at 200LFM
 1.12°C/W (typ.), at 300LFM
 0.97°C/W (typ.), at 400LFM

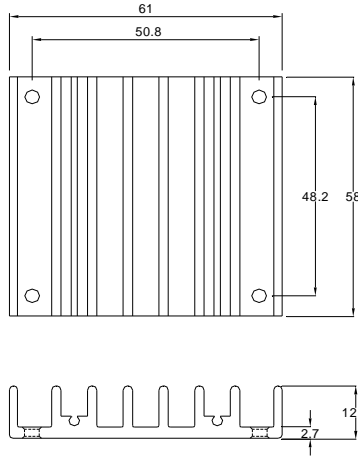

M-C091 (G6610120402)
Transverse Heat Sink

Rca:
 4.70°C/W (typ.), natural convection
 2.89°C/W (typ.), at 100LFM
 2.30°C/W (typ.), at 200LFM
 1.88°C/W (typ.), at 300LFM
 1.59°C/W (typ.), at 400LFM

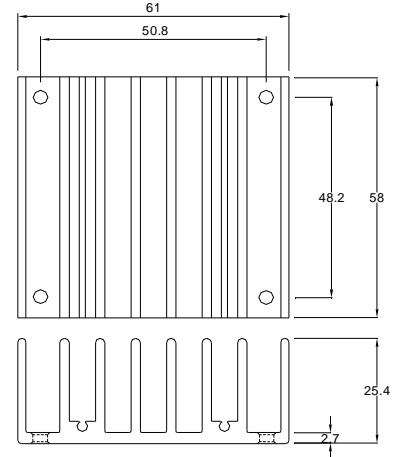

M-C092 (G6610130402)
Transverse Heat Sink

Rca:
 3.00°C/W (typ.), natural convection
 1.44°C/W (typ.), at 100LFM
 1.17°C/W (typ.), at 200LFM
 1.04°C/W (typ.), at 300LFM
 0.95°C/W (typ.), at 400LFM

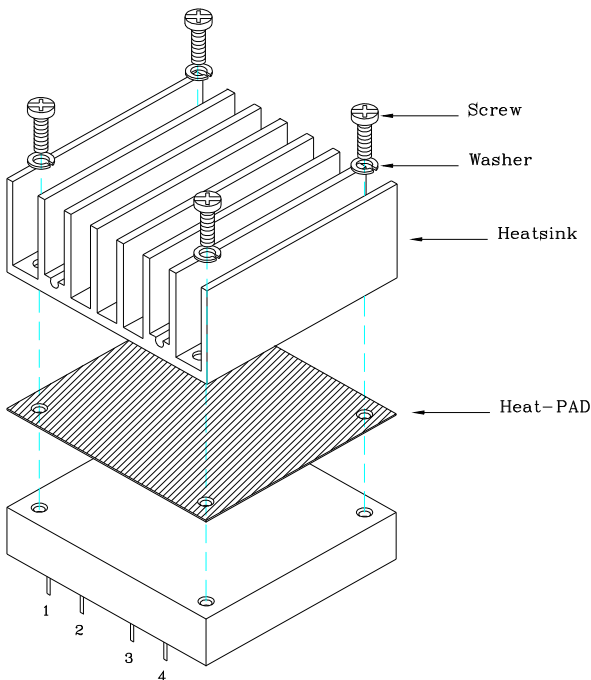

THERMAL PAD: SZ 56.9*60*0.25 mm (G6135041091)
 SCREW: SMP+SW M3*8L
 (G75A1300322)



CHB100W Series

Application Note V13 November 2013

6.7 Efficiency VS. Load

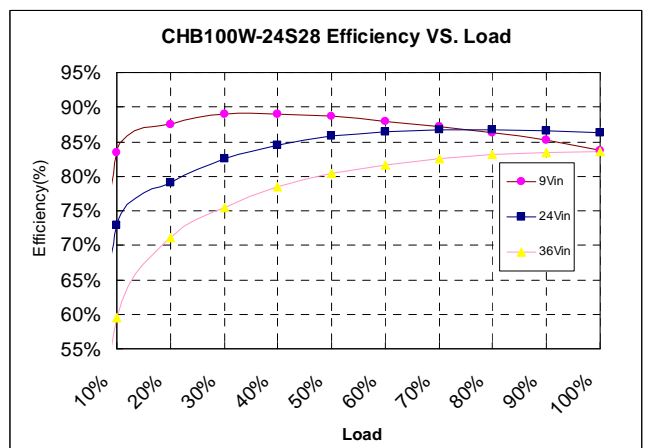
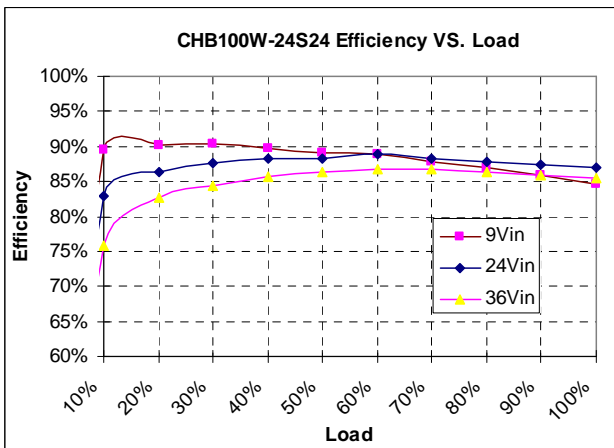
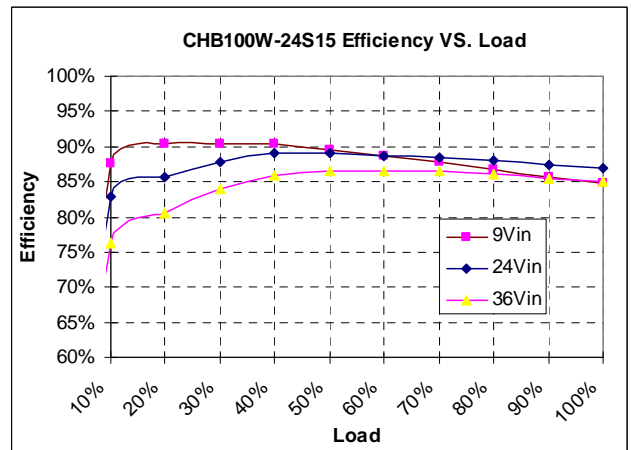
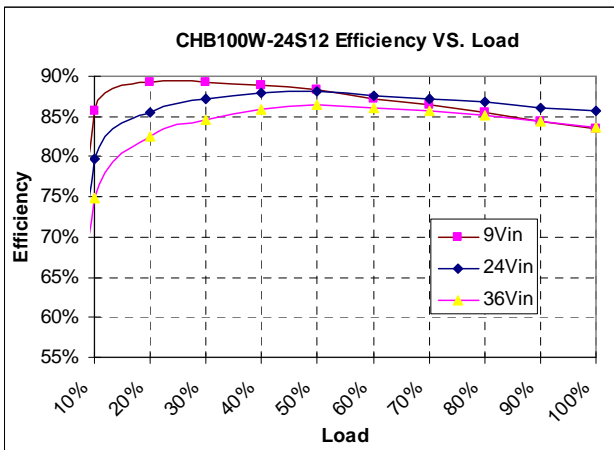
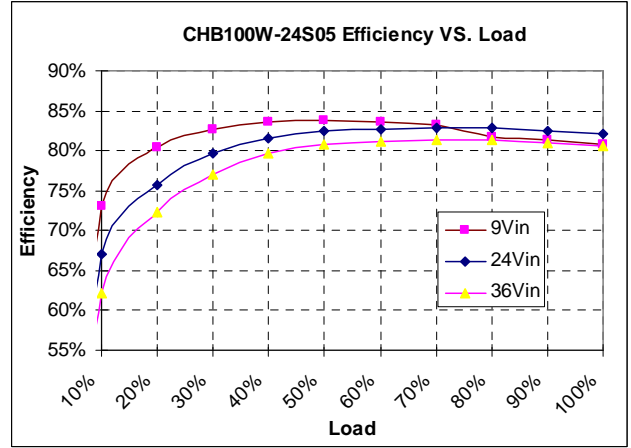
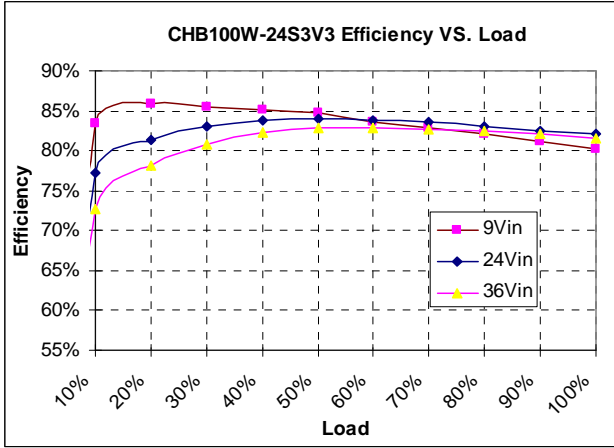



CHB100W Series

Application Note V13 November 2013

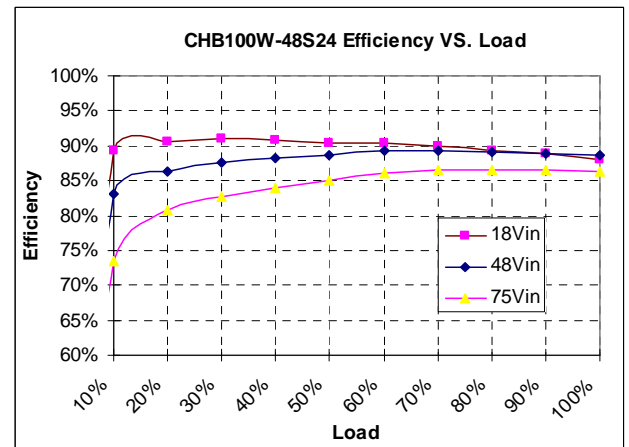
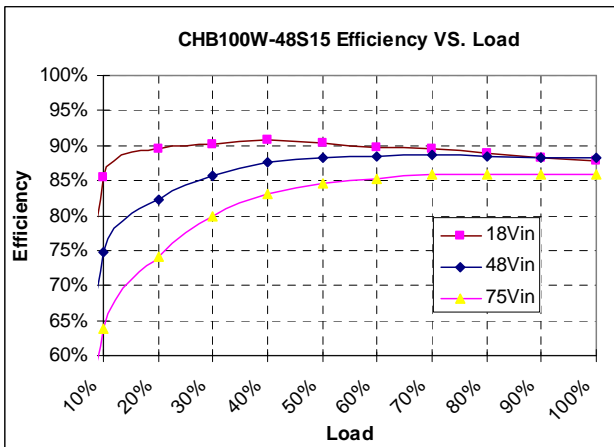
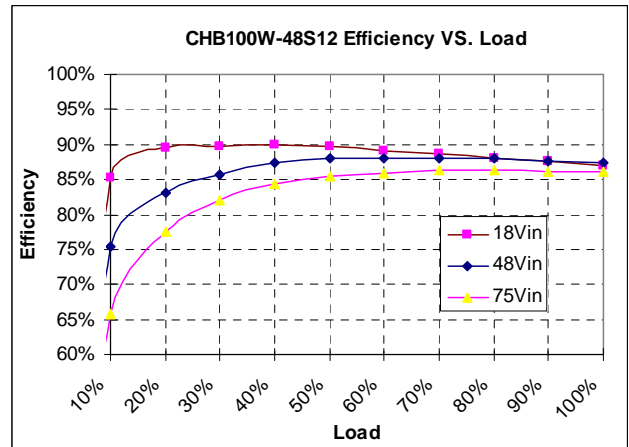
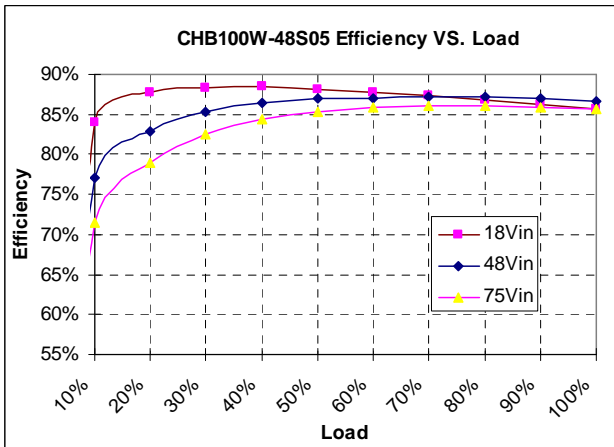
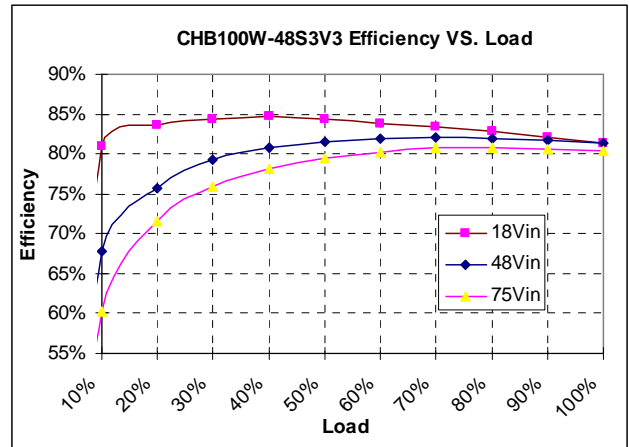
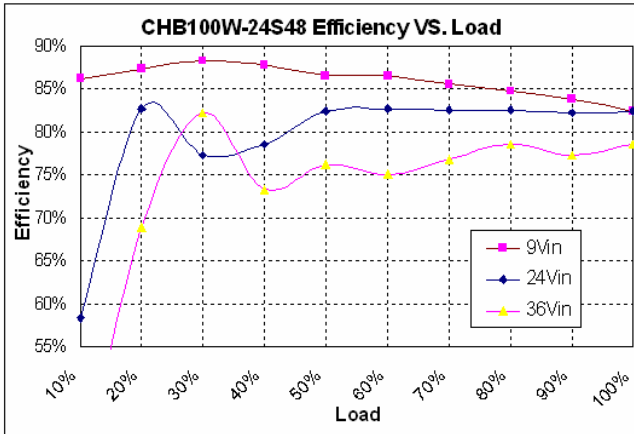



CHB100W Series

Application Note V13 November 2013

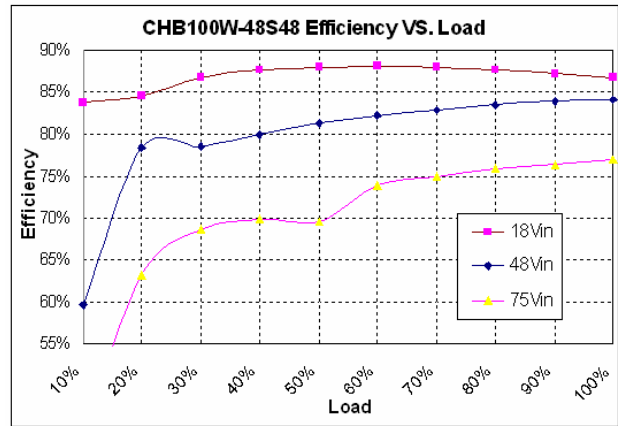
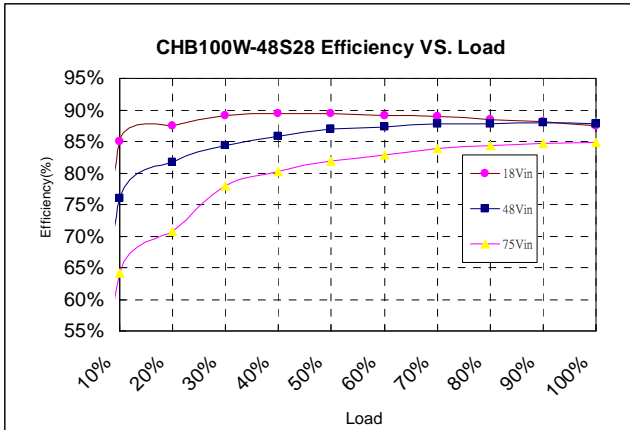

Note: The Y-axis (Efficiency) shows values from 55% to 90% EXCEPT on models 24S15, 48S12, 48S15 and 48S24. Because these models may operate at efficiencies of 90% or higher, the Y-axis (Efficiency) shows values from 60% to 100%.

6.8 Test Set-Up

The basic test set-up to measure parameters such as efficiency and load regulation is shown below. When testing the modules under any transient conditions please ensure that the transient response of the source is sufficient to power the equipment under test. We can calculate:

- Efficiency
- Load regulation and line regulation.

The value of efficiency is defined as:

$$\eta = \frac{V_o \times I_o}{V_{in} \times I_{in}} \times 100\%$$

Where:

- V_o is output voltage,
- I_o is output current,
- V_{in} is input voltage,
- I_{in} is input current.

The value of load regulation is defined as:

$$Load.reg = \frac{V_{FL} - V_{NL}}{V_{NL}} \times 100\%$$

Where:

- V_{FL} is the output voltage at full load
- V_{NL} is the output voltage at no load

The value of line regulation is defined as:

$$Line.reg = \frac{V_{HL} - V_{LL}}{V_{LL}} \times 100\%$$

Where:

- V_{HL} is the output voltage of maximum input voltage at full load.

V_{LL} is the output voltage of minimum input voltage at full load.

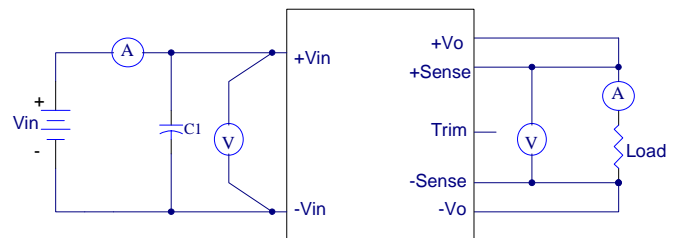

CHB100W Series Test Setup

6.9 Output Voltage Adjustment

Output may be externally trimmed ($\pm 10\%$) with a fixed resistor or an external trimpot as shown (optional). Model specific formulas for calculating trim resistors are available upon request as a separate document.

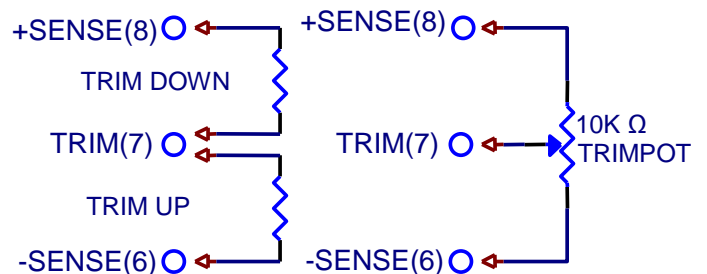

In order to trim the voltage up or down, one needs to connect the trim resistor either between the trim pin and -Vo for trim-up or between trim pin and +Vo for trim-down. The output voltage trim range is $\pm 10\%$. This is shown:



CHB100W Series

Application Note V13 November 2013

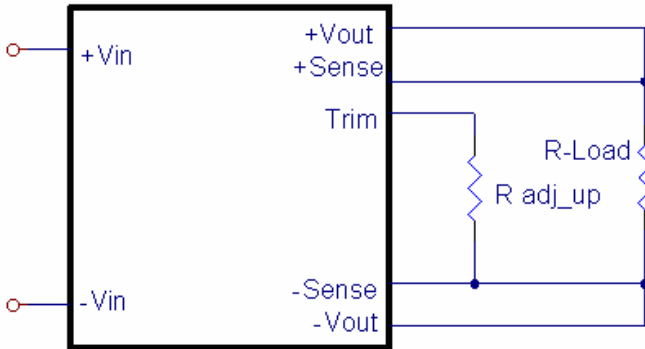

Trim-up Voltage Setup

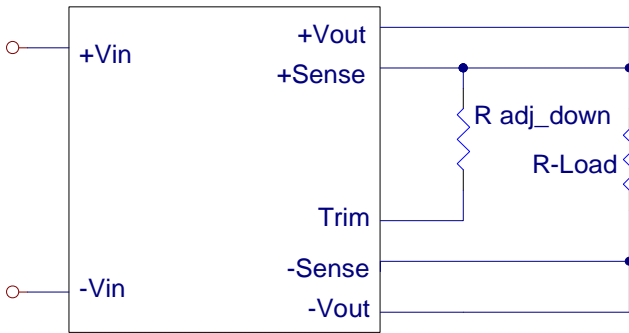

Trim-down Voltage Setup

V _{out} (V)	R1 (KΩ)	R2 (KΩ)	R3 (KΩ)	V _r (V)	V _f (V)
3.3V	3.0	12	4.3	1.24	0.46
5V	2.32	3.3	0	2.5	0
12V	9.1	51	5.1	2.5	0.46
15V	12	56	8.25	2.5	0.46
24V	20	100	7.5	2.5	0.46
28V	23.7	150	6.2	2.5	0.53
48V	36	270	5.1	2.5	0.46

Trim Resistor Values

The value of R_{trim_up} defined as:

$$R_{trim_up} = \left(\frac{R_1(V_r - V_f(\frac{R_2}{R_2 + R_3}))}{V_o - V_{o_nom}} \right) - \frac{R_2 R_3}{R_2 + R_3} \text{ (K}\Omega\text{)}$$

Where:

R_{trim_up} is the external resistor in KΩ.

V_{o_nom} is the nominal output voltage.

V_o is the desired output voltage.

R_1, R_2, R_3 and V_r are internal components.

For example, to trim-up the output voltage of 12V module (CHB100W-48S12) by 5% to 12.6V, R_{trim_up} is calculated as follows:

$$V_o - V_{o_nom} = 12.6 - 12 = 0.6V$$

$$R_1 = 9.1 \text{ K}\Omega, R_2 = 51 \text{ K}\Omega, R_3 = 5.1 \text{ K}\Omega,$$

$$V_r = 2.5 \text{ V}, V_f = 0.46 \text{ V}$$

$$R_{trim_up} = \frac{18.944}{0.6} - 4.636 = 26.94 \text{ (K}\Omega\text{)}$$

The value of R_{trim_down} defined as:

$$R_{trim_down} = \frac{R_1 \times (V_o - V_r)}{V_{o_nom} - V_o} - R_2 \text{ (K}\Omega\text{)}$$

Where:

R_{trim_down} is the external resistor in KΩ.

V_{o_nom} is the nominal output voltage.

V_o is the desired output voltage.

R_1, R_2, R_3 and V_r are internal components.

For example: to trim-down the output voltage of 12V module (CHB100W-48S12) by 5% to 11.4V, R_{trim_down} is calculated as follows:

$$V_{o_nom} - V_o = 12 - 11.4 = 0.6 \text{ V}$$

$$R_1 = 9.1 \text{ K}\Omega, R_2 = 51 \text{ K}\Omega, V_r = 2.5 \text{ V}$$

$$R_{trim_down} = \frac{9.1 \times (11.4 - 2.5)}{0.6} - 51 = 83.98 \text{ (K}\Omega\text{)}$$

6.10 Output Remote Sensing

The CHB100W series converters have the capability to remotely sense both lines of its output. This feature moves the effective output voltage regulation point from the output of the unit to the point of connection of the remote sense pins. This feature automatically adjusts the real output voltage of the CHB100W series in order to compensate for voltage drops in distribution and maintain a regulated voltage at the point of load. The remote-sense voltage range is:

$$[(+V_{out}) - (-V_{out})] - [(+Sense) - (-Sense)] \leq 10\% \text{ of } V_{o_nominal}$$

If the remote sense feature is not to be used, the sense pins should be connected locally. The +Sense pin should be connected to the +V_{out} pin at the module and the -Sense pin should be connected to the -V_{out} pin at the module. This is shown in the schematic below.

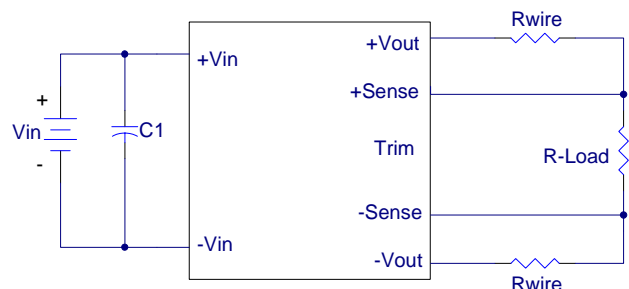



CHB100W Series

Application Note V13 November 2013

Note: Although the output voltage can be varied (increased or decreased) by both remote sense and trim, the maximum variation for the output voltage is the larger of the two values not the sum of the values. The output power delivered by the module is defined as the voltage at the output terminals multiplied by the output current. Using remote sense and trim can cause the output voltage to increase and consequently increase the power output of the module if output current remains unchanged. Always ensure that the output power of the module remains at or below the maximum rated power. Also be aware that if $V_{o.set}$ is below nominal value, $P_{out.max}$ will also decrease accordingly because $I_{o.max}$ is an absolute limit. Thus, $P_{out.max} = V_{o.set} \times I_{o.max}$ is also an absolute limit.

6.11 Output Ripple and Noise

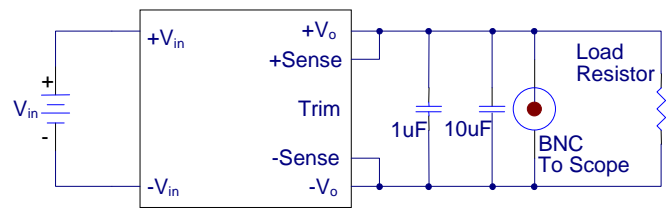

Output ripple and noise is measured with 1.0uF ceramic and 10uF solid tantalum capacitors across the output.

6.12 Output Capacitance

The CHB100W series converters provide unconditional stability with or without external capacitors. For good transient response, low ESR output capacitors should be located close to the point of load. PCB design emphasizes low resistance and inductance tracks in consideration of high current applications. Output capacitors with their associated ESR values have an impact on loop stability and bandwidth. Cincon's converters are designed to work with load capacitance up to 1000uF per amp.



CHB100W Series

Application Note V13 November 2013

7. Safety & EMC

7.1 Input Fusing and Safety Considerations

The CHB100W series converters have no internal fuse. In order to achieve maximum safety and system protection, always use an input line fuse. We recommended a 20A time delay fuse for 24V_{in} models, and 10A for 48V_{in} models. It is recommended that the circuit have a transient voltage suppressor diode (TVS) across the input terminal to protect the unit against surge or spike voltage and input reverse voltage (as shown).

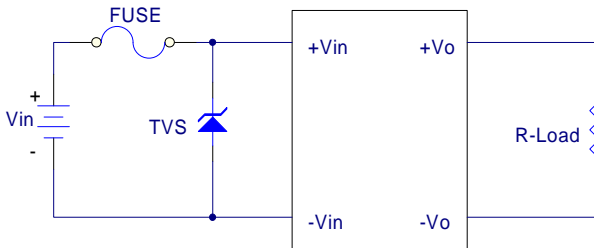

7.2 EMC Considerations

Suggested Circuits for Conducted EMI CLASS A & CLASS B

(1) EMI and conducted noise meet EN55022 Class A specifications:

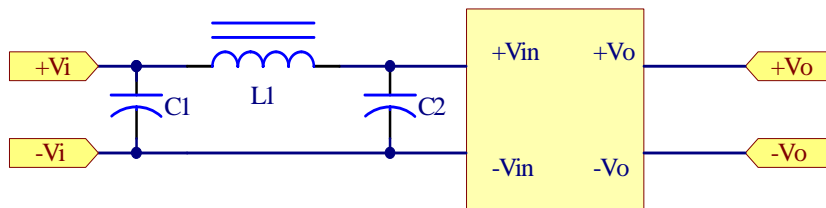

Model No.	C1	C2	L1
CHB100W-24S3V3	47uF/50V	47uF/50V	3.4uH
CHB100W-24S05	47uF/50V	47uF/50V	3.4uH
CHB100W-24S12	47uF/50V	47uF/50V	3.4uH
CHB100W-24S15	47uF/50V	47uF/50V	3.4uH
CHB100W-24S24	47uF/50V	47uF/50V	3.4uH
CHB100W-24S28	47uF/50V	47uF/50V	3.4uH
CHB100W-24S48	47uF/50V	47uF/50V	3.4uH
CHB100W-48S3V3	47uF/100V	47uF/100V	3.4uH
CHB100W-48S05	47uF/100V	47uF/100V	3.4uH
CHB100W-48S12	47uF/100V	47uF/100V	3.4uH
CHB100W-48S15	47uF/100V	47uF/100V	3.4uH
CHB100W-48S24	47uF/100V	47uF/100V	3.4uH
CHB100W-48S28	47uF/100V	47uF/100V	3.4uH
CHB100W-48S48	47uF/100V	47uF/100V	3.4uH

Note: C1, C2 NIPPON CHEMI-CON KY series aluminum capacitors



CHB100W Series

Application Note V13 November 2013

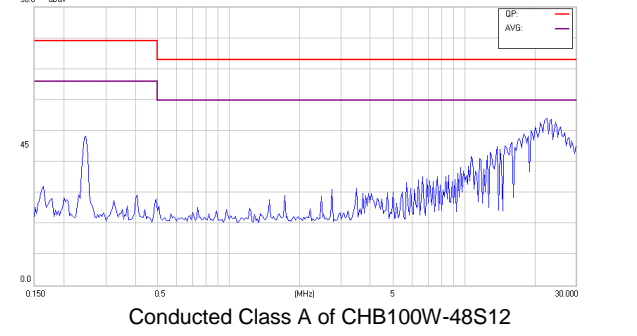
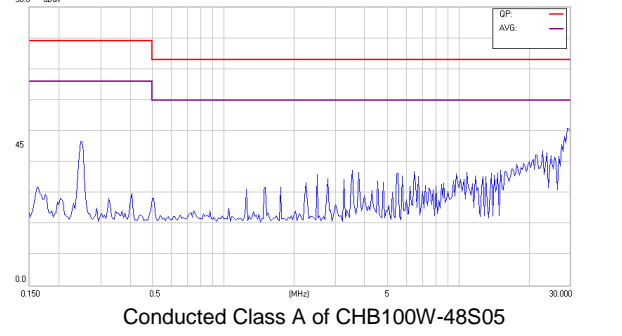
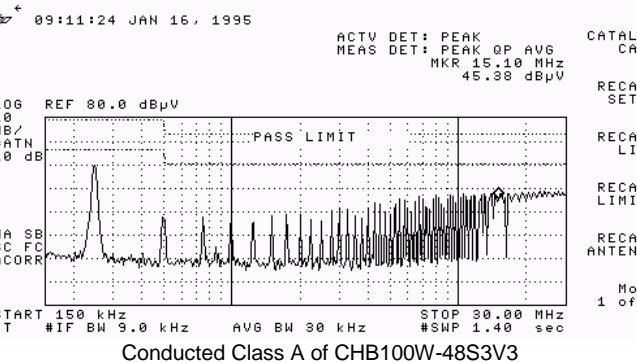
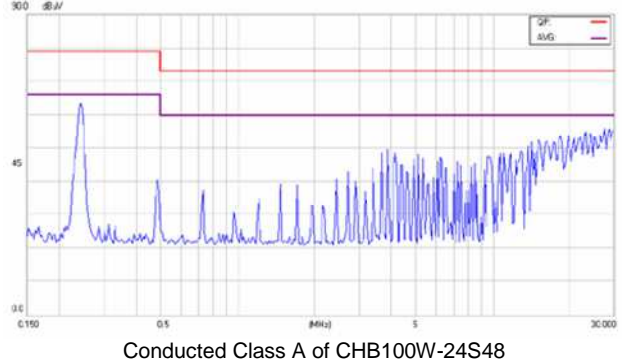
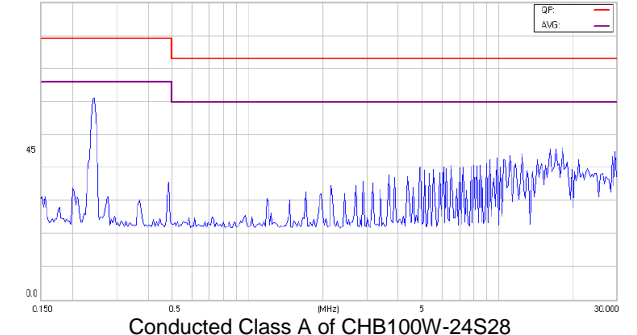
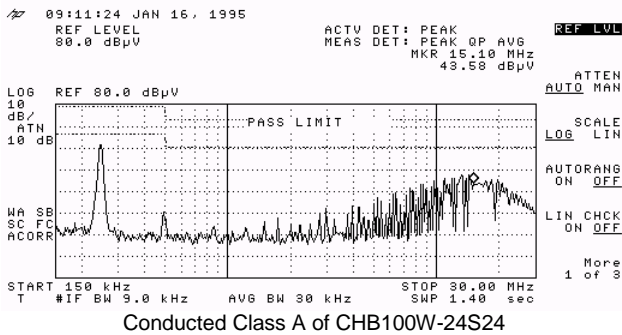
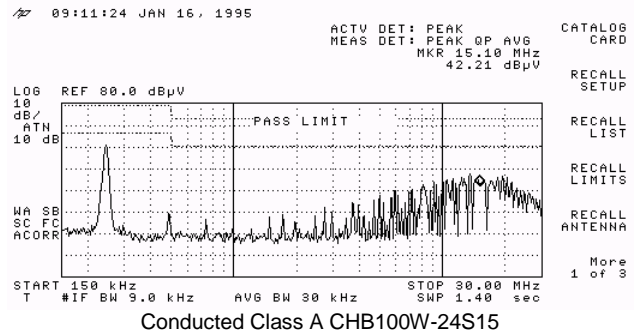
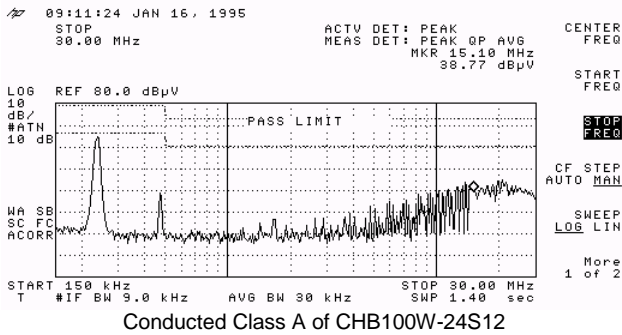
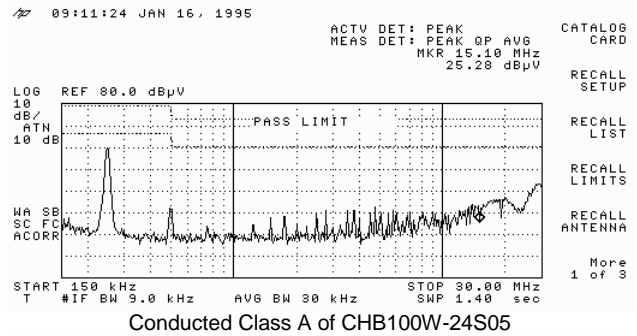
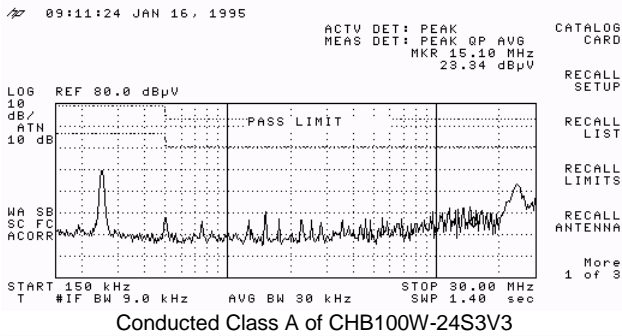



CHB100W Series

Application Note V13 November 2013

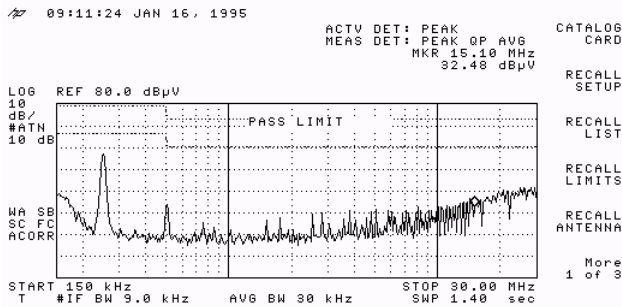

Conducted Class A of CHB100W-48S15

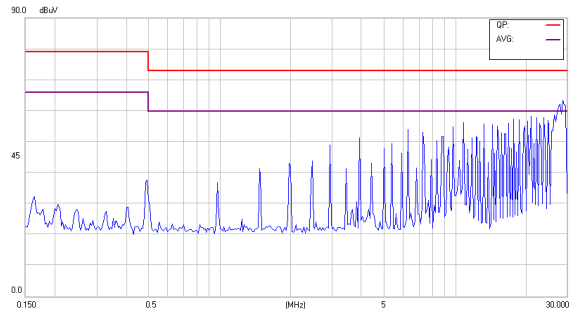

Conducted Class A of CHB100W-48S24

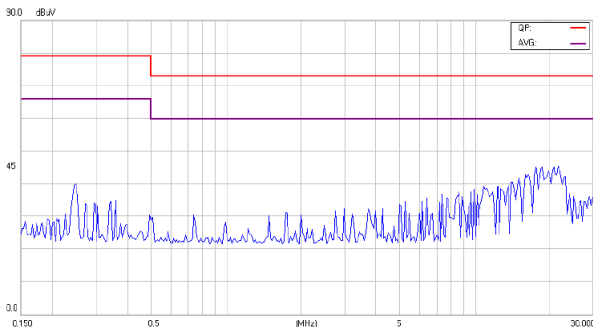

Conducted Class A of CHB100W-48S28

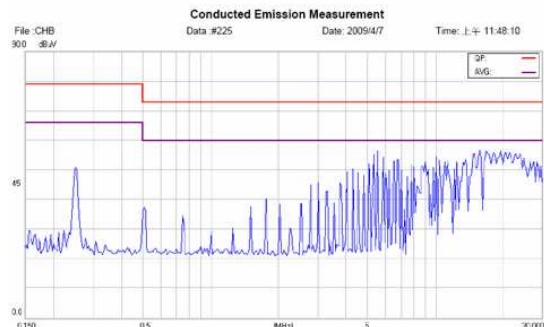

Conducted Class A of CHB100W-48S48

(2) EMI and conducted noise meet EN55022 Class B specifications:

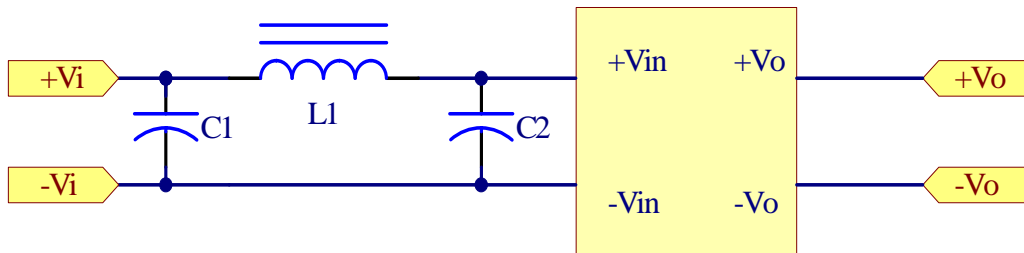

Model No.	C1	C2	L1
CHB100W-24S3V3	220uF/50V	220uF/50V	3.4uH
CHB100W-24S05	220uF/50V	220uF/50V	3.4uH
CHB100W-24S12	220uF/50V	220uF/50V	3.4uH
CHB100W-24S15	220uF/50V	220uF/50V	3.4uH
CHB100W-24S24	220uF/50V	220uF/50V	3.4uH
CHB100W-24S28	220uF/50V	220uF/50V	3.4uH
CHB100W-48S3V3	47uF/100V	47uF/100V	3.4uH
CHB100W-48S05	47uF/100V	47uF/100V	3.4uH
CHB100W-48S12	47uF/100V	47uF/100V	3.4uH
CHB100W-48S15	47uF/100V	47uF/100V	3.4uH
CHB100W-48S24	47uF/100V	47uF/100V	3.4uH
CHB100W-48S28	47uF/100V	47uF/100V	3.4uH

Note: C1, C2 NIPPON CHEMI-CON KY series aluminum capacitors.



CHB100W Series

Application Note V13 November 2013

(3) EMI and conducted noise meet EN55022 Class B specifications for V_o : 48V

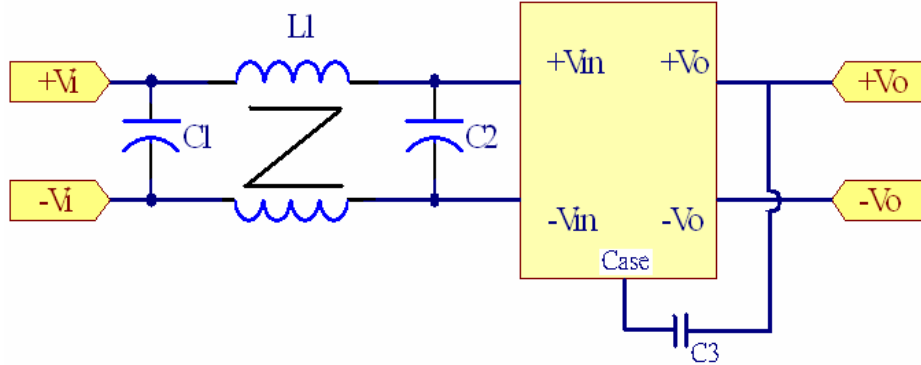

Model No.	C1	C2	C3	L1
CHB100W-24S48	100uF/50V	100uF/50V	2200pF/2KV	0.53mH
CHB100W-48S48	47uF/100V	47uF/100V	2200pF/2KV	0.53mH

Note: C1, C2 NIPPON CHEMI-CON KY series aluminum capacitors, C3 is ceramic capacitors.

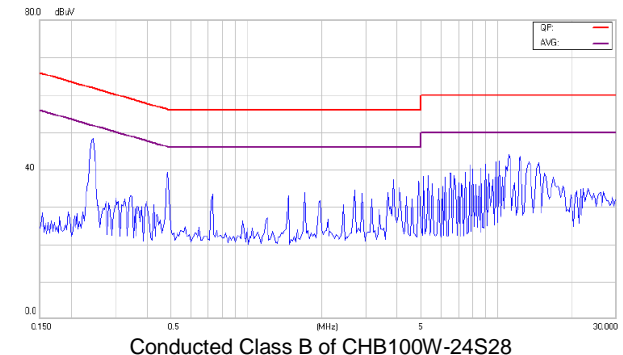
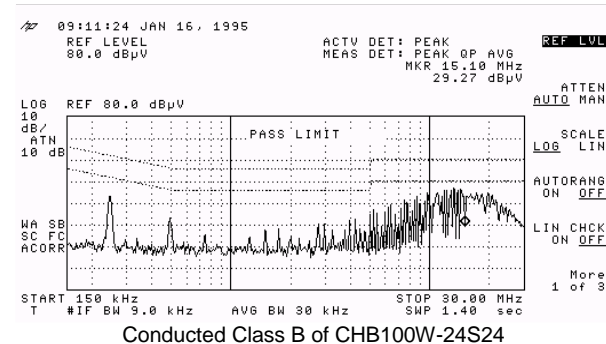
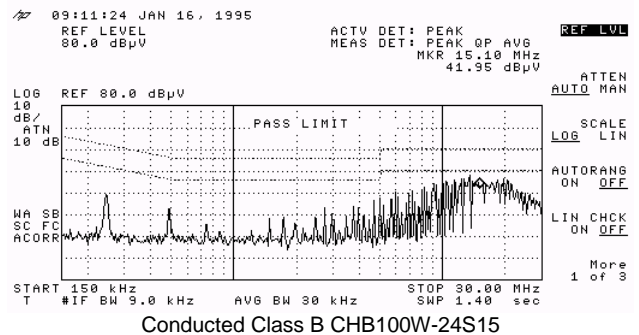
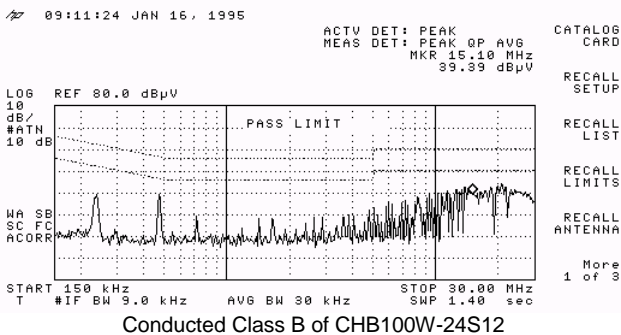
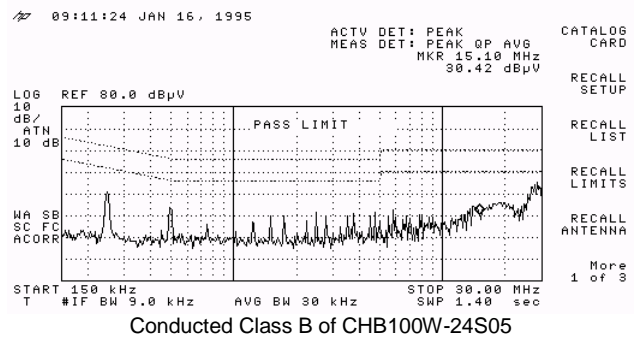
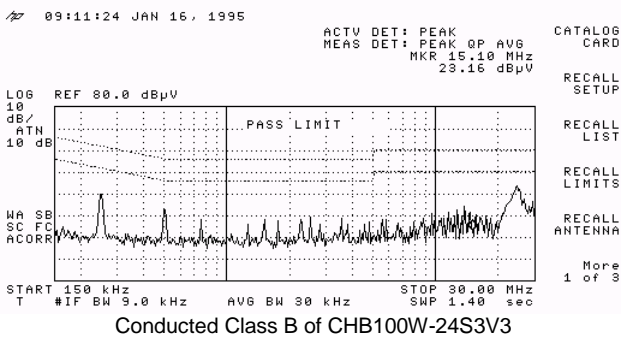



CHB100W Series

Application Note V13 November 2013

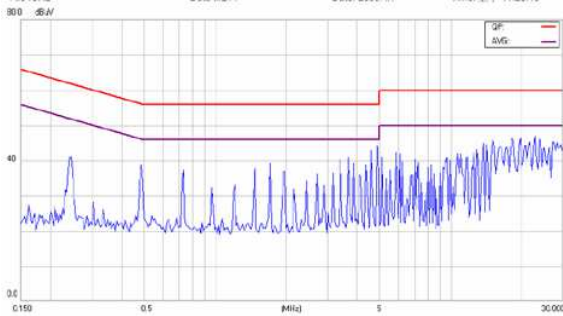

Conducted Class B of CHB100W-24S48

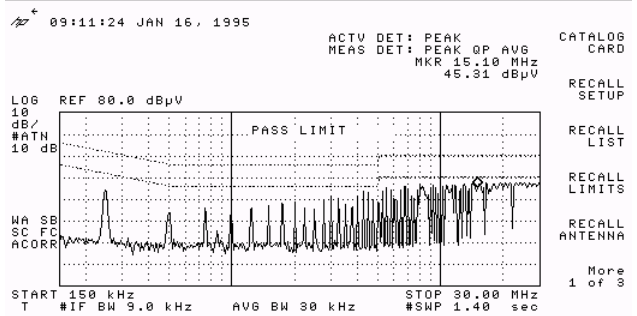

Conducted Class B of CHB100W-48S3V3

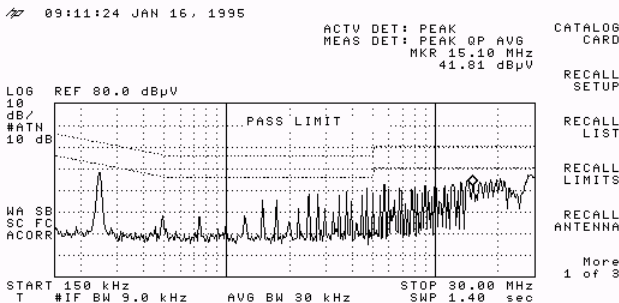

Conducted Class B of CHB100W-48S05

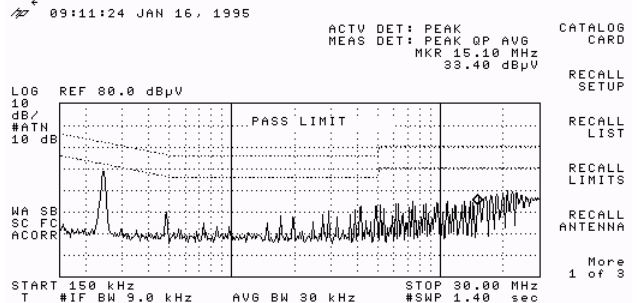

Conducted Class B of CHB100W-48S12

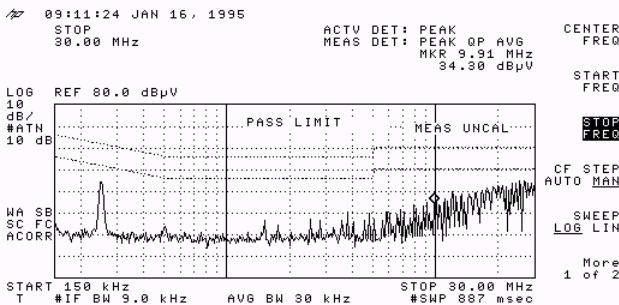

Conducted Class B of CHB100W-48S15

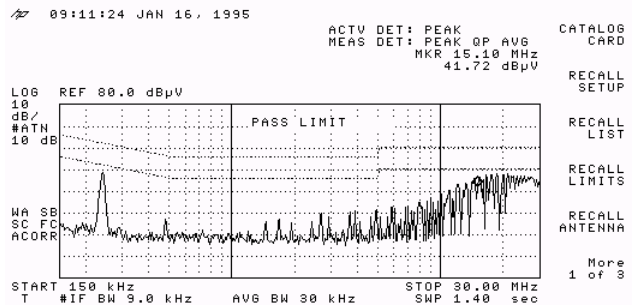

Conducted Class B of CHB100W-48S24

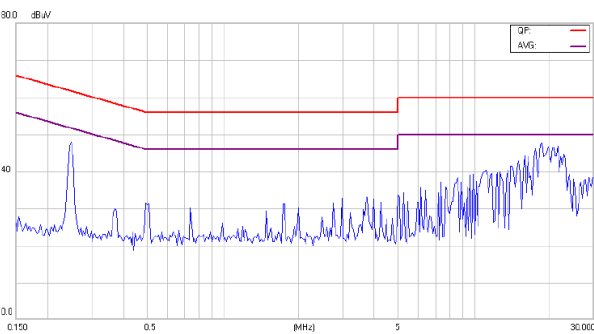

Conducted Class B of CHB100W-48S28

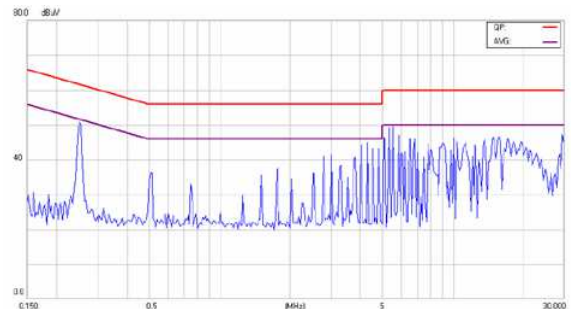

Conducted Class B of CHB100W-48S48



CHB100W Series

Application Note V13 November 2013

8. Part Number

Format: CHB100W – II X OO L-Y

Parameter	Series	Nominal Input Voltage	Number of Outputs	Output Voltage	Remote ON/OFF Logic	Mounting Inserts
Symbol	CHB100W	II	X	OO	L	Y (Option)
Value	CHB100W	24: 24 Volts 48: 48 Volts	S: Single	3V3: 3.3 Volts 05: 05 Volts 12: 12 Volts 15: 15 Volts 24: 24 Volts 28: 28 Volts 48: 48 Volts	None: Positive N: Negative	C: Clear Mounting Insert (3.2mm DIA.)

9. Mechanical Specifications

9.1 Mechanical Outline Diagrams

All Dimensions In Inches(mm)
 Tolerances Inches: X.XX= ±0.02 , X.XXX= ±0.010
 Millimeters: X.X= ±0.5 , X.XX=±0.25

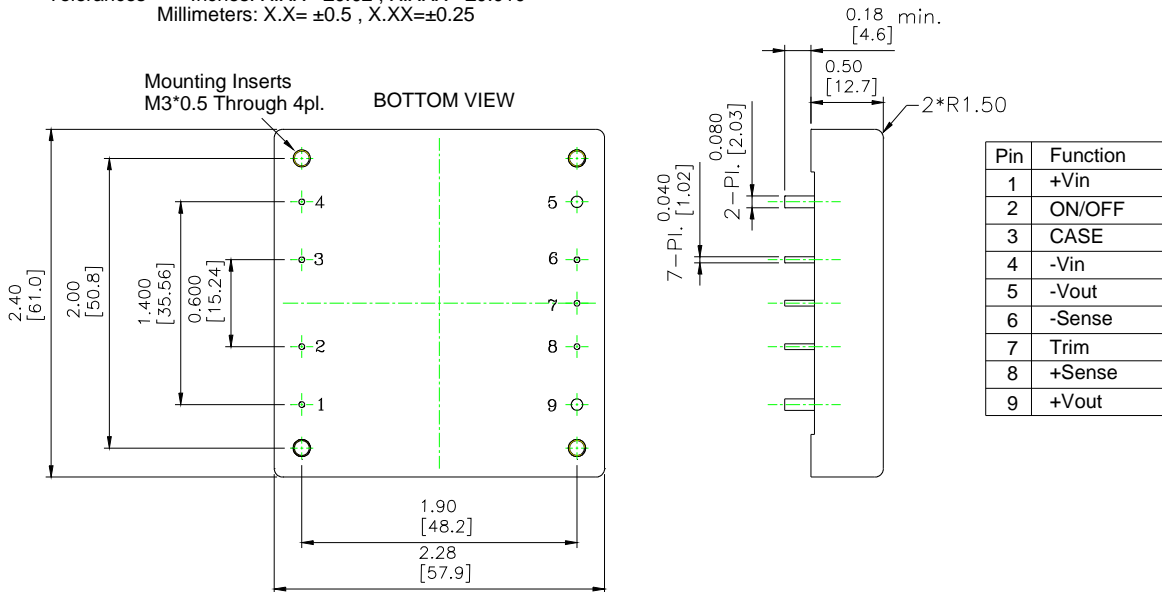

CINCON ELECTRONICS CO., LTD.

Headquarters:

14F, No.306, Sec.4, Hsin Yi Rd.
 Taipei, Taiwan
 Tel: 886-2-27086210
 Fax: 886-2-27029852
 E-mail: support@cincon.com.tw
 Web Site: <http://www.cincon.com>

Factory:

No. 8-1, Fu Kung Rd.
 Fu Hsing Industrial Park
 Fu Hsing Hsiang,
 Chang Hua Hsien, Taiwan
 Tel: 886-4-7690261
 Fax: 886-4-7698031

Cincon North America:

1655 Mesa Verde Ave. Ste 180
 Ventura, CA 93003
 Tel: 805-639-3350
 Fax: 805-639-4101
 E-mail: info@cincon.com